

# ZX-B044

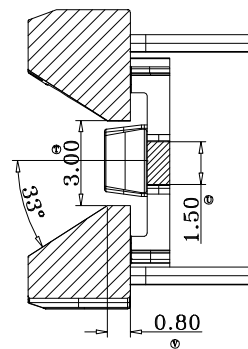

REV.	REVISIONS REC.		DATE	REV.	REVISIONS REC.		DATE
1				4			
2				5			
3				6			
DRAWN & DRAFTED BY	LIU WEI QIANG	TOLERANCES		ANGLE:	TITLE:		
CHECKED & APPROVED BY	LI JUN	0<L≤4 ±0.1	pin pitch	±1°	BASE(2+2P)		
		4<L≤16 ±0.2	±0.2	UNIT:	BOBBIN MATERIAL:	UL REC.	
		16<L≤63 ±0.3		MM	PA66	UL 94V-0	
				SCALE:	PIN MATERIAL:	PIN TENSION LOAD:	
					CP WIRE	0.8KG MIN	
					DATE:	DRAWING NO.	REV.
					2003.03.28	ZX-B044	A01

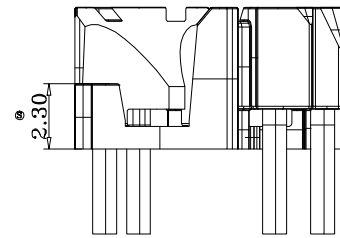
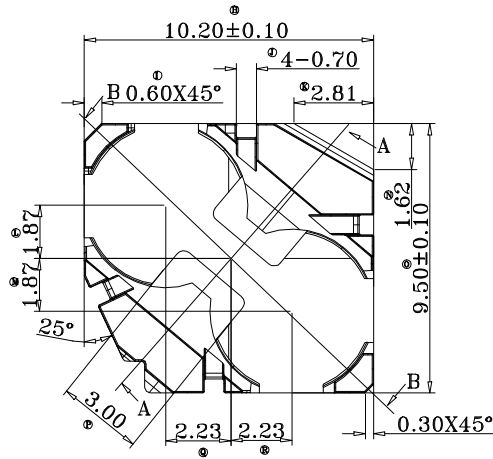
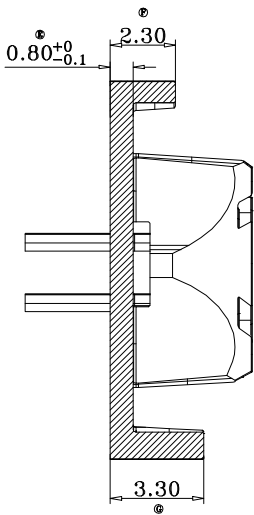
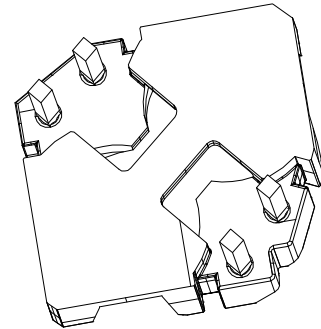
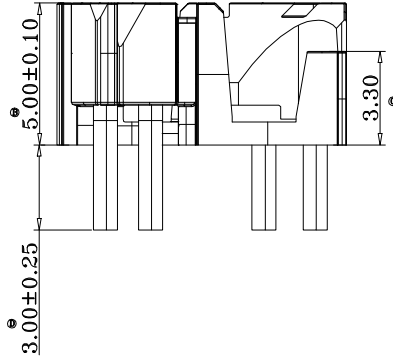
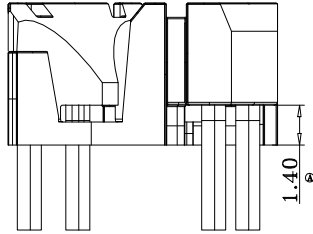

**智信电子塑胶有限公司**  
**ZHI XIN ELECTRONICS PLASTIC CO., LTD.**  
 TEL:0769-86389901-2 FAX:0769-86389903

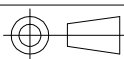

DATE: 2003.03.28

DRAWING NO. ZX-B044

REV. A01