

ZX-25BD

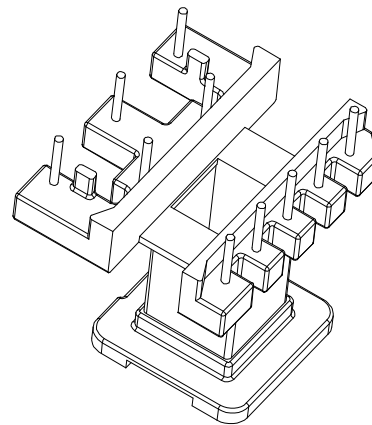

| REV. | REVISIONS | REC. | DATE | REV. | REVISIONS | REC. | DATE |
|-----------------------|-----------|------------------|------|---------------------|-----------|-----------------------------|------|
| 1 | | | | 4 | | | |
| 2 | | | | 5 | | | |
| 3 | | | | 6 | | | |
| DRAWN & DRAFTED BY | | LIU WEI QIANG | | TOLERANCES | | ANGLE: $\pm 1^\circ$ | |
| CHECKED & APPROVED BY | | ZHANG YONG | | pin pitch | | TITLE: EE-25(5+5P) | |
| | | 0 < L ≤ 4 ±0.1 | | UNIT: MM | | BOBBIN MATERIAL: PM-9820 | |
| | | 4 < L ≤ 16 ±0.2 | | SCALE: | | UL REC. UL 94V-0 | |
| | | 16 < L ≤ 63 ±0.3 | | DATE: 2018.12.08 | | PIN MATERIAL: CP WIRE | |
| | | | | DRAWING NO. ZX-25BD | | PIN TENSION LOAD: 1.2KG MIN | |
| | | | | REV. A01 | | | |

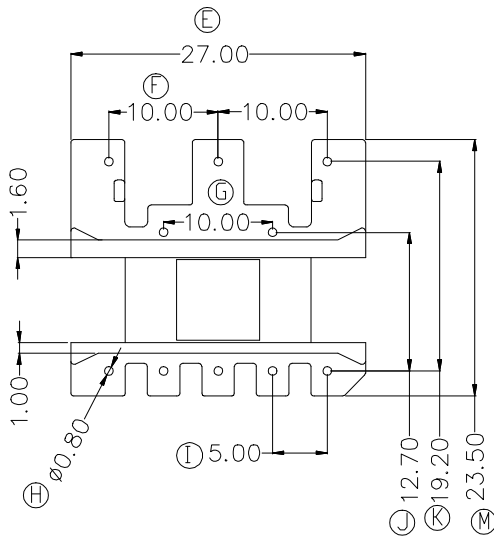
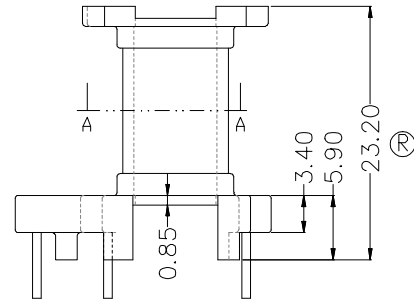
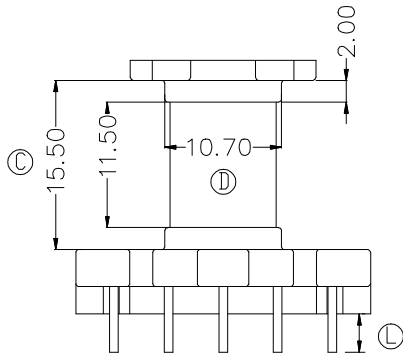
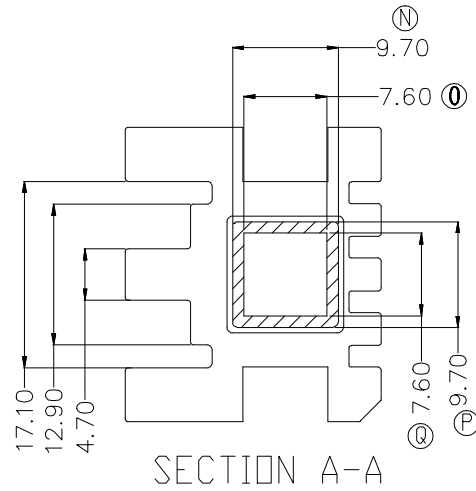
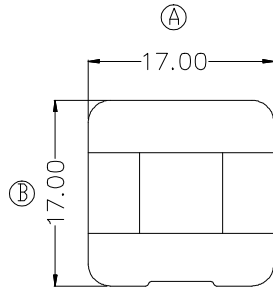

智信电子塑胶有限公司

ZHI XIN ELECTRONICS PLASTIC CO., LTD.
TEL:0769-86389901-2 FAX:0769-86389903

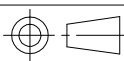

DATE: 2018.12.08

DRAWING NO. ZX-25BD

REV. A01