

ZX-55E

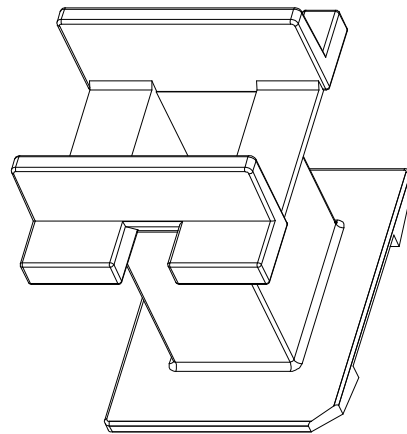

REV.	REVISIONS REC.		DATE	REV.	REVISIONS REC.		DATE
1				4			
2				5			
3				6			
DRAWN & DRAFTED BY		LIU WEI QIANG		TOLERANCES		ANGLE: $\pm 1^\circ$	
CHECKED & APPROVED BY		LIN JUN		0 < L ≤ 4 ±0.1		UNIT: MM	
				4 < L ≤ 16 ±0.2		TITLE: EE-55	
				16 < L ≤ 63 ±0.3		BOBBIN MATERIAL: PHENOLIC	
				pin pitch ±0.2		UL REC. UL 94V-0	
						PIN TENSION LOAD:	
						SCALE:	
						DATE: 2014.04.26	
						DRAWING NO. ZX-55E	
						REV. A01	

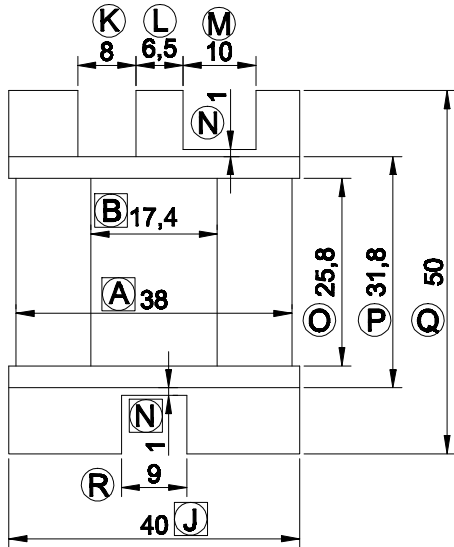
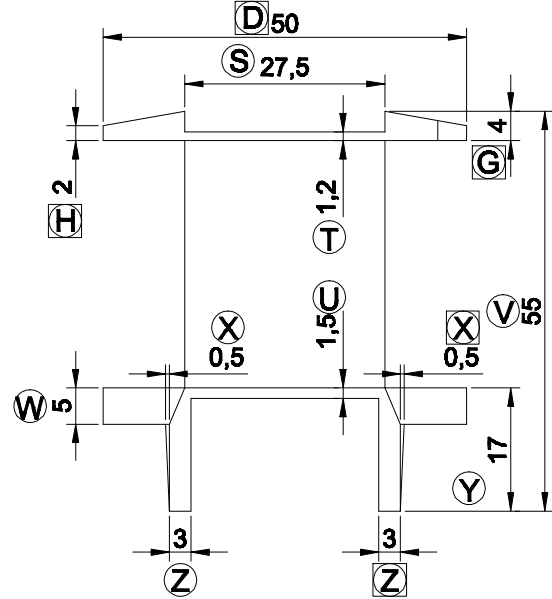
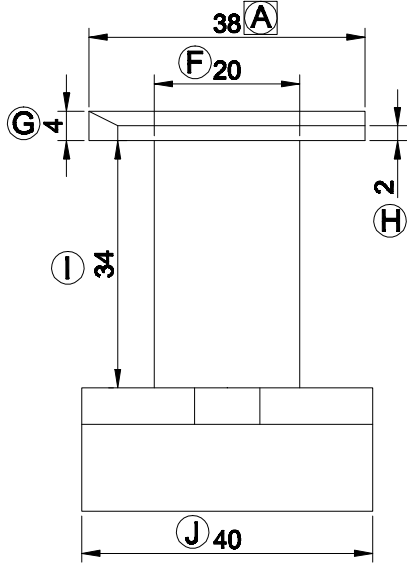
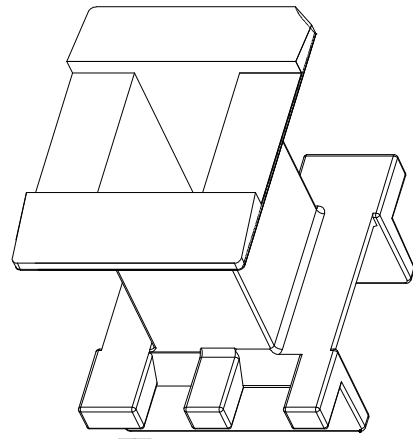
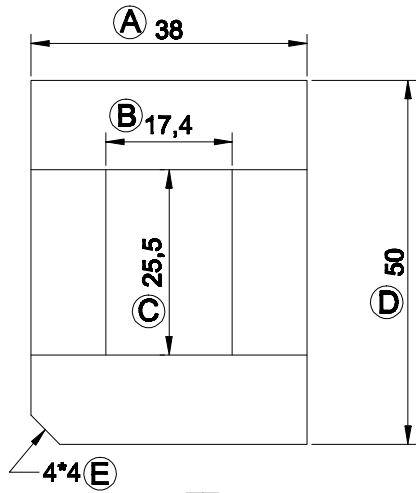

智信电子塑胶有限公司
 ZHI XIN ELECTRONICS PLASTIC CO., LTD.
 TEL:0769-86389901-2 FAX:0769-86389903

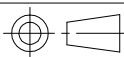

DATE: 2014.04.26

DRAWING NO. ZX-55E

REV. A01